



RELEASE GUIDE

ERDAS IMAGINE

September 29, 2016



Contents

About This Release	4
ERDAS IMAGINE Product Tiers	4
New Platforms	4
ArcGIS 10.4.1	4
Windows 10	4
New Technology	5
IMAGINE SAR Feature	5
Overview	6
Requirements	6
New Operators for Spatial Modeler	7
Compute Affine Coefficients	7
Create Affine Transform	7
Define Metadata	8
Define Security Info	9
Features Information	9
Get Pixel Values	9
Orthorectify	10
Remove Georeferencing.....	10
Set Thematicity.....	11
Warp.....	11
General Spatial Modeler	12
Subset dialog.....	12
Upload Model to Smart M.App.....	12
General ERDAS IMAGINE	12
Support for Web (Pseudo) Mercator	12

DeltaCue	13
System Requirements	13
ERDAS IMAGINE (including ERDAS ER Mapper, IMAGINE Photogrammetry and ORIMA)13	
ERDAS IMAGINE System Requirements Notes	15
PRO600	16
PRO600 System requirements notes	17
Issues Resolved	18
IMAGINE Essentials.....	18
IMAGINE Photogrammetry	21
IMAGINE Professional	21
IMAGINE Advantage.....	23
IMAGINE AutoDTM.....	23
IMAGINE Stereo Analyst.....	23
PRO600	24
About Us	25



ABOUT THIS RELEASE

This document describes the enhancements for ERDAS IMAGINE 2016 v16.1, including IMAGINE Photogrammetry (formerly LPS Core) and ERDAS ER Mapper. Although the information in this document is current as of the product release, see the Hexagon Geospatial Support website for the most current version.

This release includes both enhancements and fixes. For information on fixes that were made to ERDAS IMAGINE for this release, see the Issues Resolved section.

This document is only an overview and does not provide all of the details about the product's capabilities. See the online help and other documents provided with ERDAS IMAGINE for more information.

ERDAS IMAGINE PRODUCT TIERS

ERDAS IMAGINE[®] performs advanced remote sensing analysis and spatial modeling to create new information. In addition, with ERDAS IMAGINE, you can visualize your results in 2D, 3D, movies, and on cartographic-quality map compositions. The core of the ERDAS IMAGINE product suite is engineered to scale with your geospatial data production needs. Optional modules (add-ons) providing specialized functionalities are also available to enhance your productivity and capabilities.

IMAGINE Essentials[®] is the entry-level image processing product for map creation and simple feature collection tools. IMAGINE Essentials enables serial batch processing.

IMAGINE Advantage[®] enables advanced spectral processing, image registration, mosaicking and image analysis, and change detection capabilities. IMAGINE Advantage enables parallel batch processing for accelerated output.

IMAGINE Professional[®] includes a production toolset for advanced spectral, hyperspectral, and radar processing, and spatial modeling. Includes ERDAS ER Mapper.

NEW PLATFORMS

ARCGIS 10.4.1

ERDAS IMAGINE 2016 v16.1 has been tested and declared Supported when using an installed and licensed version of ArcGIS 10 through 10.4.1 in order to provide Geodatabase support libraries. Alternatively the IMAGINE Geodatabase Support component (based on ArcGIS Engine 10.1) can be installed to provide Geodatabase support.

WINDOWS 10

ERDAS ER Mapper is supported on Windows 10 with the release of the v16.1 Update

NEW TECHNOLOGY

IMAGINE SAR FEATURE

One of the key development areas targeted for this update of ERDAS IMAGINE was to release a new add-on module called IMAGINE SAR Feature.

IMAGINE SAR Feature is an interactive Operational Workstation which enables an Analyst to optimize radar image processing and viewing in a real-time environment. Using the Workstation, advanced SAR algorithms can be rapidly modified and viewed to allow enhancement optimization. The full image can then be processed into Information Products. Available functionality includes speckle suppression, image annealing, Target Detection, Change Detection and Feature Extraction. Functionality can be combined into processing regimens to convert radar imagery from any sensor into industry-standard information. The Workstation is fully integrated within ERDAS IMAGINE and is sold as an add-on module.

Functionality appears on the SAR Feature tab of the ERDAS IMAGINE icon panel

- Operational Workstation – All functionality is designed into a process-flow driven Workstation. All Tools and algorithm parameters are in one place.
- Fast Image Display – Geometric and radiometric image adjustments are applied on the fly, preserving integrity of original pixel values
- All algorithms are state-of-the-art and radar-specific
- Algorithms are designed for computational efficiency, taking advantage of both multi-core and mixed CPU-GPU computing
- Smart Enhancement optimization – Image Enhancement and Information Extraction no longer requires time-consuming trial-and-error; the Analyst can optimize processing in near real-time
- Dynamically Adjust Imagery – Analyst can modify image processing regimen and see the results immediately
- Precise Mensuration – Image raster is geocoded on-the-fly into the Viewer. All measurements are based on original pixel values, image metadata and a true radar sensor model.



OVERVIEW

The SAR Feature Workstation consists of a viewer, panels to manage data, a Smart Control, and a dedicated icon panel with interactive process-flow algorithm parameters

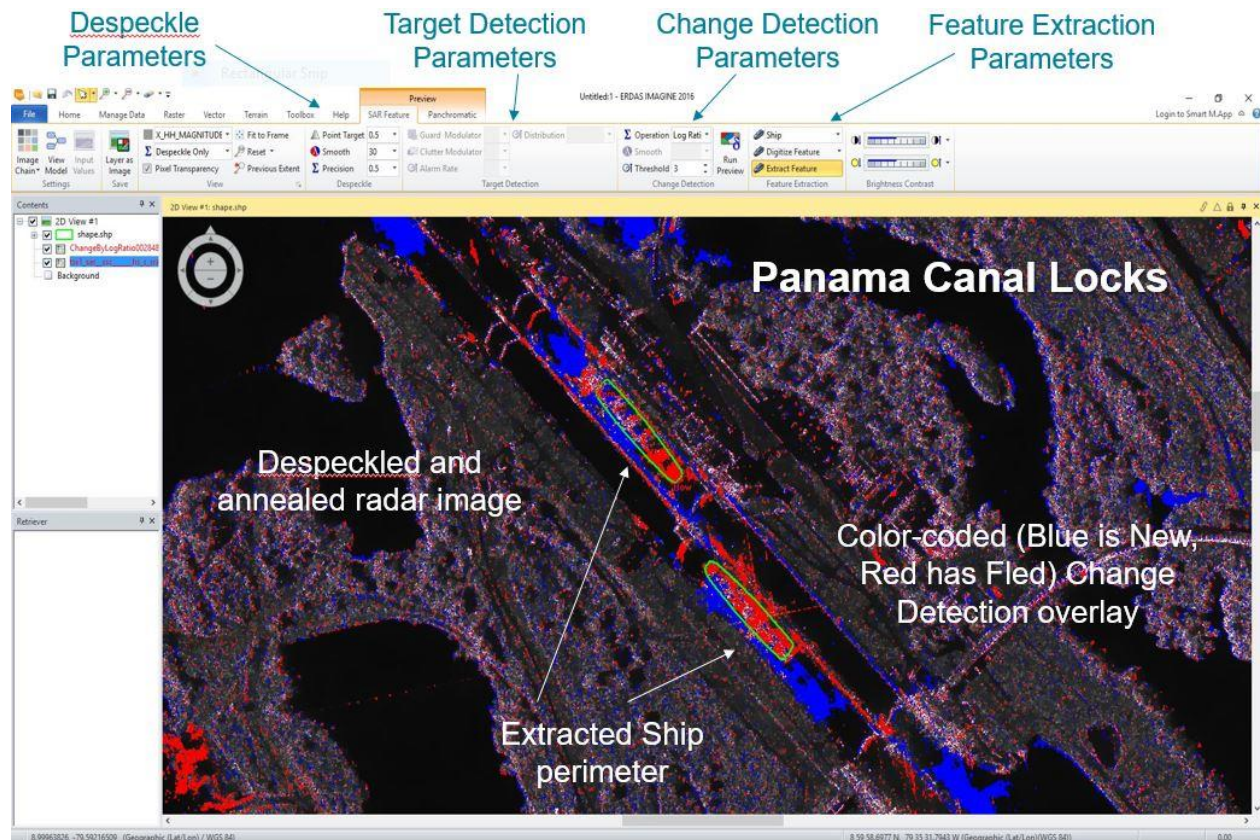

REQUIREMENTS

- IMAGINE SAR Feature is an ERDAS IMAGINE add-on delivered with the ERDAS IMAGINE 2016 v16.1 installer. A separate license must be purchased to activate this functionality.
- To fully utilize the computational sophistication of IMAGINE SAR Feature, ERDAS IMAGINE 2016 v16.1 should be installed on a modern CPU with multicore capability and with an advanced video card (from NVIDIA) so as to enable the GPU processing via CUDA (Compute Unified Device Architecture). The software is capable of running on just the CPU in the absence of a suitable GPU environment, however this is not recommended.
- To determine if your GPU is supported, or to select an optimal system for your application, please visit the [Nvidia](http://www.nvidia.com) web site. This page will indicate the Compute Capability of the various Nvidia cards available. IMAGINE SAR Feature will require Compute Capability 2.0 or higher. CUDA 7.5 is being used, therefore Nvidia driver v352.39 or above must be installed.

NEW OPERATORS FOR SPATIAL MODELER

Based on initiatives, such as the creation of Hexagon Smart M.Apps, Hexagon Geospatial has continued to add new operators to Spatial Modeler. This section is listing of the new (or modified) operators with a brief description of their capabilities. Please refer to the ERDAS IMAGINE 2016 v16.1 Help for full details of each operator, as well as to the Hexagon Geospatial Community / [Spatial Recipes](#) page for examples of Spatial Models which use many of these capabilities.

COMPUTE AFFINE COEFFICIENTS

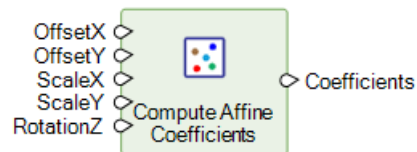

Compute coefficients of a 2D affine transformation using offsets, rotation, and scales.

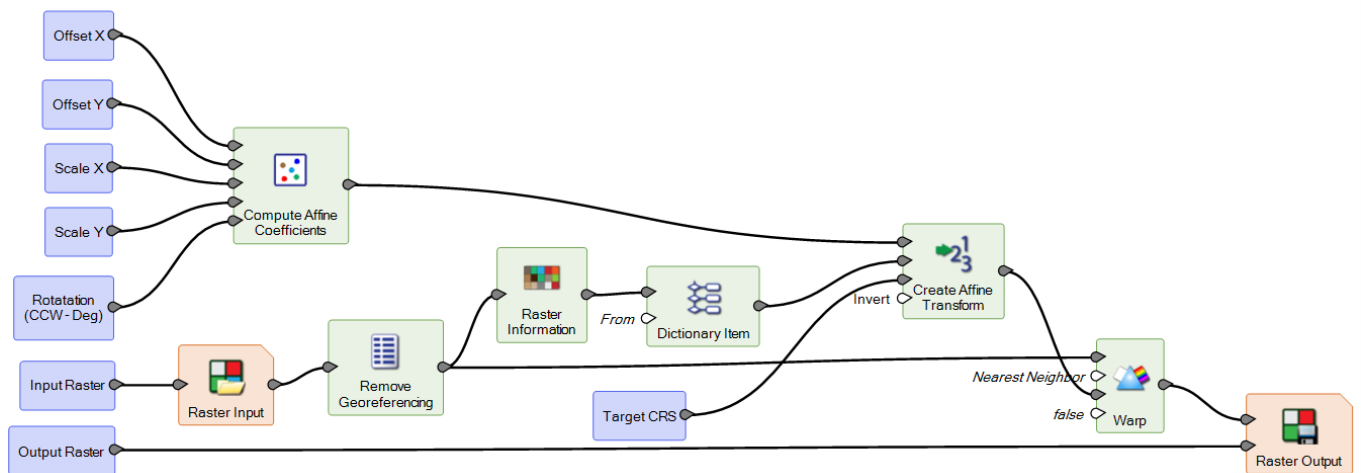

CREATE AFFINE TRANSFORM

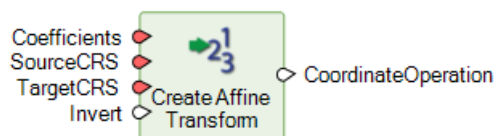

Create an affine transformation based on input affine coefficients, source CRS, and target CRS.



CREATE RSETS

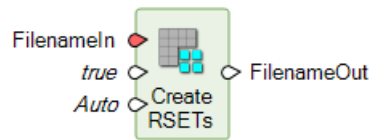

The Create RSETS operator has had two new ports added.

The **ForceRecompute** flag indicates what the behavior of the operator is with regards to existing RSETs. By default RSETs are computed if the file specified on the **FilenameIn** port already has identifiable pyramids. Even when **ForceRecompute** is set to false this operator always attempts to optimize RSET access by persisting metadata about the identified pyramids to the full resolution dataset.

The **SubsamplingMethod** port allows you to specify the name of the algorithm to be used for sub-sampling the RSETs. Valid values are "Auto", "Standard", "MaxPixelDecimation", and "Epho3x3"

DEFINE METADATA

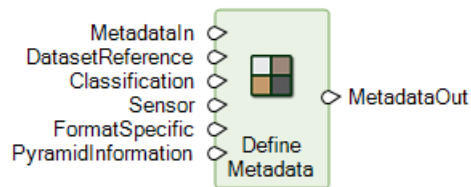

Creates or modifies an object containing Metadata for a raster dataset.

Metadata can be read from a raster dataset using the Raster Input operator (with Read Metadata = true). The Metadata object contains a small number of common fields corresponding to input ports of the Define Metadata operator: DatasetReference, Classification, Sensor, etc. Metadata values in supported formats that correspond to these fields are translated when reading. Other metadata in the raster are put in the FormatSpecific field, and can be accessed using the Dictionary Item operator.

Metadata can be written to a new raster dataset by using the Define Metadata object to attach a Metadata object just before writing with the Raster Output operator. When possible, top-level fields such as Classification and Sensor are translated to the metadata schema of the raster file format.

DEFINE SECURITY INFO

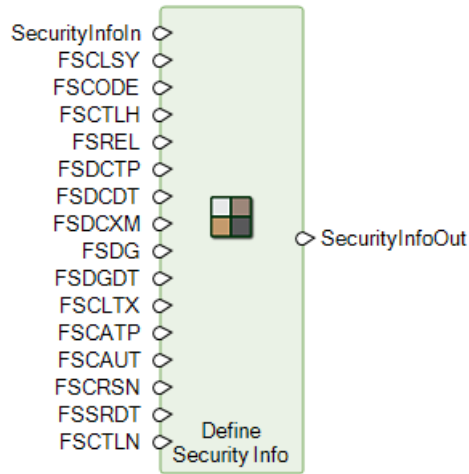

Creates a Security Info metadata object suitable for writing to raster images in formats that support it, including NITF. These security-related fields follow the NITF 2.1 file header definition as specified in section 6.1.2.1 of MIL-STD-2500C. They include the fields whose acronyms beginning with "FS", except FSCOP and FSCPYS.

FEATURES INFORMATION

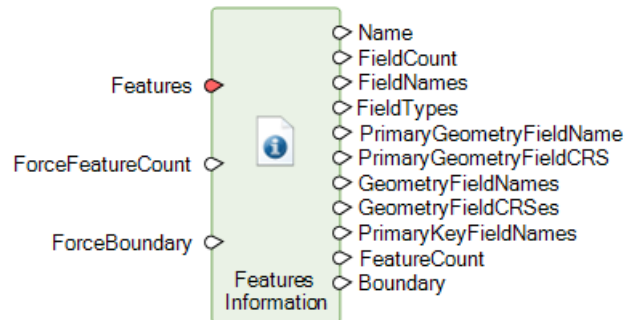

Provides basic information about features, including the number of geometries, projected coordinate system, extent, etc.

GET DRA PARAMS

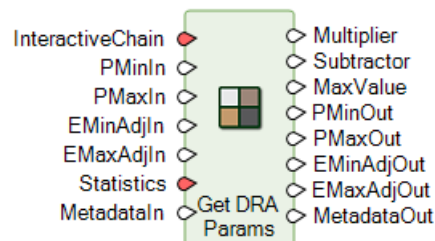

Dynamic Range Adjustment (DRA) is a technique used to perform tonal processing of raw image data, mapping it from the dynamic range of the sensor to that of a well-defined metric. The **Get DRA Params** operator can be used to acquire the necessary inputs to use with the **DRA Stretch** operator.



This operator has been modified and extended to better support the dynamic nature of DRA stretching in SIPS Image Chains.

The **EMinAdjIn** and **EMaxAdjIn** inputs specify minimum and maximum DN values for the DRA stretch range. If provided, these completely override **PMinIn**, **PMaxIn**, and any defaults for the specified **InteractiveChain**. The output ports **EMinAdjOut** and **EMaxAdjOut** provide similar tables containing the minimum and maximum DN values for the generated stretch range, whether or not **EMinAdjIn** and **EMaxAdjIn** were specified.

GET PIXEL VALUE

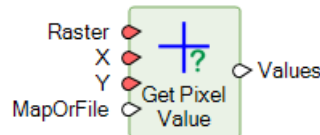

Read raster pixel values at a point. The output is an **IMAGINE.List** of **IMAGINE.Scalar** objects, one for each raster band. If a given band has **NODATA** at the specified **x, y** location, the list item for that band will be null rather than **IMAGINE.Scalar**.

When **MapOrFile** is set to "File", the coordinate inputs **X** and **Y** are interpreted as File coordinates. When **MapOrFile** is set to "Map", the coordinate inputs **X** and **Y** are interpreted as Map coordinates in the map coordinate reference system of **Raster**.

ORTHORECTIFY

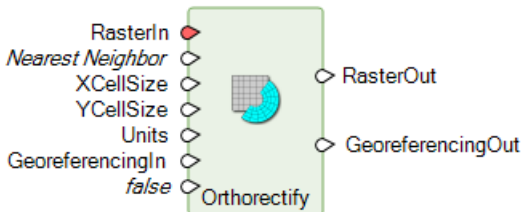

This Operator has been extended to include a **SquarePixels** port which enables the output data to be forced to have square pixel dimensions even if other inputs would suggest non-square.

RASTER TO BITMAP

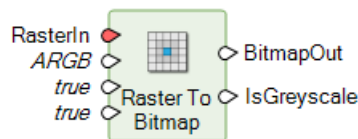

The **Raster to Bitmap** operator has a new output port called **IsGreyscale** which indicates whether **BitmapOut** is greyscale or not (so a client application displaying the bitmap can alter its behavior accordingly).

REMOVE GEOREFERENCING

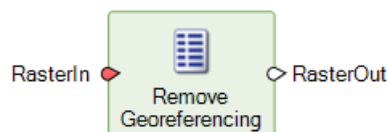

Removes the geo referencing of a raster dataset.

REMOVE ITEM

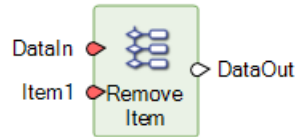

The **Remove Item** operator removes values from a Dictionary or List. The output is a copy of the **DataIn** input with the specified items deleted.

Multiple items can be removed by using **Add Port** from the operator's context menu to add additional **Item** inputs.

SET THEMATICITY

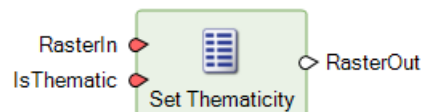

Sets or clears the IsThematic flag on a raster stream.

The thematic flag is primarily used by the Raster Output operator to indicate whether the output image should be marked (by default) as thematic or athematic. It also changes some calculations done by the Statistics operator.

STACK LAYERS

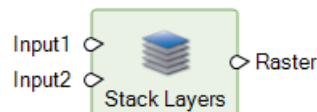

The **Stack Layers** operator has been modified so that Input1 and Input2 are not Required ports. This is particularly useful when passing the output of an Iterator to Stack Layers since the Iterator can return a variable number of outputs, including only one (or none). Previously the Stack Layers would have failed if not passed two or more inputs.

WARP

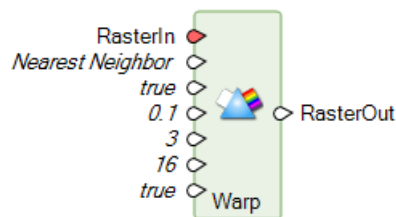

The **Warp** Operator has been extended to include a UsePyramids port. By default this port is set to True since it will result in faster processing, especially when Previewing a Spatial Model. However using pyramids from upstream data can sometimes result in unexpected results, especially if altering the pixel sizes of the original data.

For example, consider a model where you want to input a 0.6m athematic panchromatic image, filter those 0.6m pixel values using a 4x4 smoothing kernel, but then alter the spatial resolution of the Model to 2.4m (using a Warp

and Define Processing Area). If the Warp operator were allowed to use pyramids that might be available for the input image file it would only ever access pyramid layer 2 (a 4x reduction in resolution) to process in the model since the output pixel size is 4x less than the input. Consequently pyramid layer 2 would be filtered, not the original 1:1 pixels (pyramid 0), resulting in a very blurry output. Setting the UsePyramids port to False would force the Spatial Model to pull data through the Warp operator at 1:1 and therefore the filtering would be applied at the expected resolution.

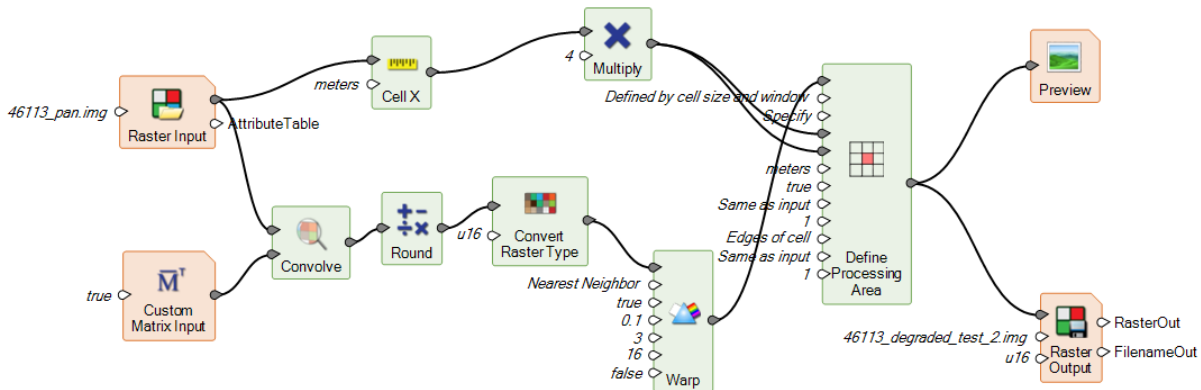

GENERAL SPATIAL MODELER

SUBSET DIALOG

In prior versions of ERDAS IMAGINE running Subset did not transfer Elevation Info, NoData masks, and other Metadata associated with the input image to the output subset. With this release the dialog now utilizes the Spatial Modeler and so is capable of retaining (or, in the case of NoData, introducing) these items of metadata, as well as providing additional output file formats.

UPLOAD MODEL TO SMART M.APP

For those customers building their own Smart M.Apps, the Spatial Model Editor now includes an option to upload a Spatial Model to M.App Studio to facilitate using the model as a geoprocessing Spatial Recipe in a Smart M.App. This provides an efficient methodology for customers to build, test and validate their models in ERDAS IMAGINE prior to transferring them for use in the Smart M.App environment.

Please note that for the upload utility to operate you will need to subscribe to the IMAGINE M.App Connect application (available at no additional cost from the [M.App Exchange](#)).

GENERAL ERDAS IMAGINE

SUPPORT FOR WEB (PSEUDO) MERCATOR

Data from the National Map (and other sources) is distributed using a Web Mercator projected coordinate system. Support for this system has been added.

DELTACUE

The DeltaCue change detection and monitoring utility now supports imagery from the Sentinel-2 and Landsat 8 platforms

SYSTEM REQUIREMENTS

ERDAS IMAGINE (INCLUDING ERDAS ER MAPPER, IMAGINE PHOTOGRAMMETRY AND ORIMA)

Computer/ Processor	64-bit: Intel 64 (EM64T), AMD 64, or equivalent (Multi-core processors are strongly recommended)
Memory (RAM)	8 GB minimum, 16 GB strongly recommended, especially for 64-bit systems
Disk Space	<ul style="list-style-type: none"> ● 4 GB for software ● 7 GB for example data Data storage requirements vary by mapping project ¹
Operating Systems ^{2,3}	<ul style="list-style-type: none"> ● Windows[®] 7 SP1 or higher, Professional and Ultimate (64-bit) ● Windows[®] 8 (Standard), Professional and Enterprise (64-bit) ⁴ ● Windows[®] 8.1 (Standard), Professional and Enterprise (64-bit) ⁴ ● Windows 10 Pro (64-bit) ⁴ ● Windows Server[®] 2008 R2 SP1 (64-bit) ● Windows Server 2012 R2 (64-bit)
Software	<ul style="list-style-type: none"> ● OpenGL 2.1 or higher (this typically comes with supported graphics cards⁵) ● Adobe[®] Reader[®] 7 or higher ● Internet Explorer[®] 7 and higher with JavaScript enabled, or Firefox[®] 3 and higher with JavaScript enabled ● Java Runtime 1.7.0.80 (optional install, required for Web Process Service (WPS) publishing to APOLLO Professional. IMAGINE Objective requires JRE, but can utilize any installed and configured JRE of version 1.7.0.80 or higher) ● Python 3.4 (32-bit is highly recommended for best compatibility, but 64-bit is Viable for



	<p>background processing). Python is optionally usable with Spatial Modeler.</p> <ul style="list-style-type: none"> • Microsoft DirectX® 9c or higher • .NET Framework 4.0 • MSXML 6.0 • Visual Studio 2013 Express Edition can be used with ERDAS ER Mapper's dynamic algorithm compiler
<p>Recommended Graphics Cards for Stereo display</p>	<ul style="list-style-type: none"> • NVIDIA® Quadro® K5200, K4200, K2200, K420 6 • NVIDIA Quadro K5000, K4000, K600 6
<p>Recommended Stereo Display Monitors</p>	<ul style="list-style-type: none"> • 120 Hz (or above) LCD Monitors with NVIDIA 3D Vision™ Kit 7
<p>Peripherals</p>	<p>All software installations require:</p> <ul style="list-style-type: none"> • One Windows-compatible mouse with scroll wheel or equivalent input device • Printing requires Windows-supported hardcopy devices 8 <p>Software security (Intergraph Licensing 11.13.2) requires one of the following:</p> <ul style="list-style-type: none"> • Ethernet card, or • One USB port for hardware key <p>Advanced data collection requires one of the following hand controllers: 9</p> <ul style="list-style-type: none"> • TopoMouse™ or TopoMouse USB™ • Immersion 3D Mouse • MOUSE-TRAK • Stealth 3D (Immersion), S3D-E type, Serial Port • Stealth Z, S2-Z model, USB version • Stealth V, S3-V type (add as a serial device) • 3Dconnexion SpaceExplorer mouse 10 • EK2000 Hand Wheels • EMSEN Hand Wheels • Z/I Mouse
<p>ArcGIS, GeoMedia and Database Interoperability</p>	<ul style="list-style-type: none"> • ERDAS IMAGINE can be installed on a computer with any version of GeoMedia higher than 2014 installed. However for proper compatibility, it is recommended that GeoMedia is

installed first and that the versions correspond.

- Live linking will work between any released version of ERDAS IMAGINE 2016 and GeoMedia 2016.
- ERDAS IMAGINE can interact with both types of personal Geodatabases (*.mdb and *.gdb).
- ERDAS IMAGINE can be installed on a computer that has ArcGIS® versions 10 through 10.4.1.
- ERDAS IMAGINE and IMAGINE Photogrammetry can interact with ArcGIS Server 10 Geodatabase servers (ArcSDE). To read or interact with an Enterprise Geodatabase, you must either:
 - Install and license the appropriate version of ArcGIS for Desktop versions 10 through 10.4.1, OR
 - Install the IMAGINE Geodatabase Support (based on ArcEngine 10.1), which requires no license
- Oracle Server 12c can be used to store/read raster data as,
 - Oracle GeoRaster (.ogr) (requires Oracle Spatial),
 - SDE Raster (.sdi) (requires ArcGIS for Server) ,
- Oracle Server 12c can be used to store/read vector/feature data as,
 - Oracle features (.ofp).
 - Oracle Spatial Features (.ogv) (requires Oracle Spatial),
- Microsoft SQL Server 2014 can be used to store/read vector/feature data as,
 - SQL Server Features (.sfp)

ERDAS IMAGINE SYSTEM REQUIREMENTS NOTES

¹ Disk I/O is usually the slowest task in geospatial data processing. Faster hard disks improve productivity. Reading data from one disk, writing temporary data to a second disk, and writing data to a third disk improves performance. Disk arrays improve productivity, but some RAID options slow performance. Network disk drives are subject to network limitations.

² Server Operating Systems are not supported for IMAGINE Photogrammetry, ORIMA or ERDAS ER Mapper.

³ The 3D stereo viewing and peripheral requirements of IMAGINE Photogrammetry limit its operating system options.

⁴ ERDAS ER Mapper is not supported on Windows 8. It is considered Viable on Windows 8.1.

⁵ Windows provides a generic OpenGL driver for all supported graphics cards. However, an OpenGL-optimized graphics card and driver are recommended for these applications.

⁶ Graphics cards certified with previous versions of IMAGINE Photogrammetry and ORIMA may also be compatible, but are not certified in the current version.

⁷ Stereo Monitors certified with previous versions of IMAGINE Photogrammetry and ORIMA may also be compatible, but are not certified in the current version.

⁸ HP-RTL drivers are recommended. Windows 64-bit print servers require 64-bit print drivers.

⁹ Stealth S-Mouse (S2-S model) and MOUSE-TRAK are the only supported hand controllers in Stereo Analyst[®] for ERDAS IMAGINE.

¹⁰ 3Dconnexion SpaceExplorer mouse is supported in IMAGINE Photogrammetry.

PRO600

Computer/ Processor	64-bit: Intel 64 (EM64T), AMD 64, or equivalent (Multi-core processors are strongly recommended)
Memory (RAM)	4 GB minimum, 8 GB strongly recommended
Disk Space	<ul style="list-style-type: none"> ● 1 GB for software Data storage requirements vary by mapping project ¹¹
Operating Systems	<ul style="list-style-type: none"> ● Windows[®] 7 SP1 or higher, Professional and Ultimate (64-bit) ● Windows[®] 8 (Standard), Professional and Enterprise (64-bit)
Software	<ul style="list-style-type: none"> ● IMAGINE Photogrammetry 2016 ¹² ● One of the following products from Bentley Systems, Inc ¹² <ul style="list-style-type: none"> ○ MicroStation V8i (SS1- SS3 Update 1) ○ Bentley Map V8i (SS1 - SS3 standalone or for MicroStation) ○ Bentley Map Enterprise V8i (SS1 - SS3)
Recommended Graphics Cards	<ul style="list-style-type: none"> ● NVIDIA[®] Quadro[®] K5200, K4200, K2200, K420 ¹³ ● NVIDIA Quadro K5000, K4000, K600 ¹³
Recommended Stereo Display Monitors	<ul style="list-style-type: none"> ● 120 Hz (or above) LCD Monitors with NVIDIA 3D Vision™ Kit ¹⁴

Peripherals

All software installations require:

- One Windows-compatible mouse with scroll wheel or equivalent input device
- Printing requires Windows-supported hardcopy devices ¹⁵

Software security (Intergraph Licensing 11.11.1) requires one of the following:

- Ethernet card, or
- One USB port for hardware key

Advanced data collection requires one of the following hand controllers:¹⁶

- TopoMouse™ or TopoMouse USB™
- Immersion 3D Mouse
- MOUSE-TRAK
- Stealth 3D (Immersion), S3D-E type, Serial Port
- Stealth Z, S2-Z model, USB version
- Stealth V, S3-V type (add as a serial device)
- 3Dconnexion SpaceExplorer mouse
- EK2000 Hand Wheels
- EMSEN Hand Wheels
- Z/I Mouse

PRO600 SYSTEM REQUIREMENTS NOTES

¹¹ Disk I/O is usually the slowest task in geospatial data processing. Faster hard disks improve productivity. Reading data from one disk, writing temporary data to a second disk, and writing data to a third disk improves performance. Disk arrays improve productivity, but some RAID options slow performance. Network disk drives are subject to network limitations.

¹² Any further requirements defined by any of the listed apply implicitly to PRO600.

¹³ Graphics cards certified with previous versions of PRO600 may also be compatible, but are not certified in the current version.

¹⁴ Stereo Monitors certified with previous versions of PRO600 may also be compatible, but are not certified in the current version.

¹⁵ HP-RTL drivers are recommended. Windows 64-bit print servers require 64-bit print drivers.

¹⁶ Stealth S-Mouse (S2-S model) and MOUSE-TRAK are only supported in Stereo Analyst® for ERDAS IMAGINE.

ISSUES RESOLVED

IMAGINE ESSENTIALS

CR #	Summary – IMAGINE Essentials	Description / How to Reproduce
1-LWV52P	Gokturk MS images are shifted and scaled incorrectly when displayed in the 2D viewer	The symptom is that the Pan data is displayed correctly, but the MS data is scaled incorrectly and also shifted.
1-BC025L	“Number of simultaneous commands” in the IMAGINE Preference will not take over correctly	<p>Customer reported that the “Number of simultaneous commands” as set by IMAGINE Preference, will not be taken into account, when starting a batch job using the submit option. Once you click the Submit button, in the Submit dialog, the number of “Simultaneous process” shows 1, even if you have set more than the value 1 in the simultaneous commands setting in Preference for Batch. To recreate the problem, please do the following:</p> <ol style="list-style-type: none"> 1. Go to IMAGINE Preference > Application> Batch Processing > Set the “Number of simultaneous commands” as more than 1, as for example 6 > Save. 2. Launch IMAGINE TIFF importer 3. After loading one input file and naming output file, Click OK 4. In the Import TIFF window, click the “Batch” button. 5. Change your variable and add more files 6. Then click “Submit button”, you will see that The number of “Simultaneous Process” shows as 1, which should, as per Preference setting be, 6. But that has not been taken over correctly. <p>When you manually change the number of processes to a higher number, in the batch process, it correctly runs with the number entered in the Submit window.</p>
1-BJ4A06	ERDAS IMAGINE not persisting metadata correctly when importing ASTER data	Customer reported that ERDAS IMAGINE is not persisting metadata correctly when importing ASTER data. According to the customer, the ASTER importer has this problem from ERDAS IMAGINE 2014 v14.1 onward. It extracts the band 3n and 3b images and create a blockfile using those two data, but IMAGINE Photogrammetry gives error message: “Failed to get metadata for” the added image.
1-H8JX9N	NITF 2.1 export with embedded JPEG2000 compression can not handle NoData value in the input image.	<p>Customer reported that if NoData is defined in the raster file, Export to NITF with JPEG2000 compression option gets disabled. The customer is using GeoTIFF data from Pleiades images. The problem has been recreated with Pleiades as well as with other TIFF and IMG data. However if the NoData value is removed from the input file, the JPEG2000 compression option in the NITF export dialog doesn’t get disabled. To recreate the problem please do the following:</p> <ol style="list-style-type: none"> 1. Open the IMAGINE Exporter > Select the export format as NITF 2.1 from Imagery , and add your input data > OK 2. You will see an alert about the image mask. If you continue without dropping the mask size, you will see that the “change compression” option gets disabled. But if you lower the number of masks you can see that Change compression option remains active. 3. However if I remove the NoData Value from the Input image and do the NITF export the

		Change compression option remains enabled
1-JM6H0T	ERDAS IMAGINE does not read projection information on JP2 imagery from the National Map	Open a National Map JP2 image in ERDAS IMAGINE (2015 or 2016) and note that no projection information is recognised. Open it in another GIS package and it is reported as being in Web Mercator Auxilliary Sphere.
1-L1U03E	Help for Landsat 8 importer has incorrect specification of which MSI bands are imported	This is particularly important to fix because the table in the Help is the *only* indication to the user as to what wavelengths the imported bands represent and is therefore currently highly misleading. Go to the Manage Data tab and click Import Data. Select the "Landsat 7 or Landsat 8 from USGS " option, select a valid .tar.gz input, specify an output and click OK. In the tertiary dialog which comes up click Help. The resulting Help file includes a table which states that a Multispectral composite will consist of bands :1, 2, 3, 4, 5, 7, 9 This is incorrect. Band 6 is missing from the list, and band 9 (the Cirrus cloud band) should not be included. The actual Multispectral bands for Landsat 8 are: 1, 2, 3, 4, 5, 6, 7
1-LRPIQJ	Sentinel-2 dll not selecting correct bands for sub-images	The 10m bands in a Sentinel-2 image are supposed to be 02, 03, 04 and 08 (equating to the usual B, G, R, NIR wavelengths). However if you open a Sentinel-2 image using the "Only10MeterBnads" sub-image option it does not appear to load the correct bands - the fourth band of the image (which is supposed to be Band 08) does not appear to be Band 08. It might be Band 05, but it certainly isn't Band 08. You can test this by starting two 2D Views and loading one with the Sentinel-2 image loaded using defaults (which will load all 13 bands at 10m resolution) and the second using the Sub-Image tab and the "Only10MeterBands" option selected. On the Multipsectral tab, use the band pull-downs to manual set the RGB display to 08, 04, 03 and note that the displays are different
1-LRRTXR	ERDAS IMAGINE displays artefacts in Sentinel-2 imported images.	<p>Customer reported that ERDAS IMAGINE 2016 displays artefacts in Sentinel-2 when imported. According to the customer if they instead use the RGB importer in ESA's SNAP v3.0, those artefacts are not found.</p> <p>The ERDAS IMAGINE 2016 software is working as designed - when opening a Sentinel-2 image which covers more than one UTM zone the granules must be reprojected to a common projected coordinate system. So if the image covers both Zone 31 and Zone 32, all the zone 31 granules might be reprojected to Zone 32. This reprojection is performed using Nearest Neighbor resampling and so the standard NN resampling "artefacts" are observed in those granules that have had to be reprojected. Such effects become more frequent the further away from the base Zone you proceed.</p> <p>For v16.1 we will alter the default behavior from NN resampling to Cubic Convolution (IM-34140). The SAFE dataset will still be opened as a single image, but the visual appearance of the resampling applied to granules that must be reprojected will be minimised by the use of CC resampling.</p> <p>For ERDAS IMAGINE 2017 an enhancement request has been submitted requesting that the dataset be openable as Zone-specific sub-images so that resampling can be avoided (but at the cost of only accessing a zone-specific section of the image at a time, as is provided by SNAP).</p>
1-QLCKZK	ERDAS IMAGINE 2016 crashes while opening Sentinel-2 Level 2A atmospheric corrected data	Customer reported that IMAGINE 2016.0 crashes while opening Sentinel-2 Level 2A atmospheric corrected data in *.SAFE format.
1-BM7ATC	Python API (help)- Please add a link to Operator Limitation in Workflow.	Description from customer: In the "Python Scripting in Spatial Modeler Workflows" it states under the heading Operator Limitations "The syntax for a given operator is documented in the Spatial Model Editor online-help" but there is no link from here

1-KX0K1N	Unable to connect to Google Earth Pro.	<p>When Google Earth Pro is installed users are unable to connect to it from ERDAS IMAGINE.</p> <p>In ERDAS IMAGINE 2016 v16.1 the Google Earth tab has been re-enabled to be visible and to interact with Google Earth.</p> <p>The Google Earth connection will also work with Google Earth Pro, but the necessary API is only installed with Google Earth, so you must install it as well.</p> <p>Also note that Google has ceased support for the API used for this feature. Therefore, the Google Earth connection may cease to operate with future releases of Google Earth / Google Earth Pro.</p>
1-LC793Y	Problem building pyramids and statistics	Customer reported that ERDAS IMAGINE crashed while performing ISOCCLASS classification with 368 band hyperspectral data. The following error occurs while creating the statistics and pyramid: Error: "Warning in ethr_ThreadCreate: Thread creation failed: Not enough storage is available to process this command".
1-M7JGP8	"Correct the Alert problem" - remains even after recreating pyramids using "Edit Image Metadata"	After computing pyramids using the "Edit Image Metadata" dialog, when you load the images again they sometimes still come up with "Correct the Alert problem" in the table contents and it still reads that pyramids need to be updated...and one has to run it again.
1-QK5K4B	With region set as Netherlands, Create Map Composition operator fails when the OS region is set to Netherlands.	Create Map Composition operator fails to generate an output when the Operating System region is set to Netherlands. The same work flow executed successfully with an English OS.
1-QK5K6B	Create Geospatial PDF operator fails when the OS region is set to Netherlands.	Create Geospatial operator fails to generate an output when the Operating System region is set to Netherlands. The same work flow executed successfully with an English OS.
1-LBFZUT	Some projections missing in finland plb file	Enhancement request to add the following EPSG projections from epsg.plb to finland.plb: EPSG:3067 , EPSG:5048, EPSG:25834, EPSG:3046, EPSG:25835, EPSG:3047, EPSG:25836, EPSG:3048, EPSG:3045, EPSG:3049
1-LD8QW4	Incorrect name for EPSG:3067	<p>In ERDAS IMAGINE 2016, the EPSG:3067 entries are shown as: "ETRS89 / ETRS-TM35FIN (3067)"</p> <p>However according to EPSG Registry (epsg-registry.org), the official name is: "ETRS89 / ETRS-TM35FIN(E,N)"</p>
1-RCVW1M	EPSG code 25832 and 4647 are mixed up	When exporting an *.img formatted image to a TIFF format, its EPSG code is incorrectly changed from 25832 to 4647. This causes wrong positioning of the exported image
1-ROZSSD	Incorrect parameters for EPSG:5650	The parameters of EPSG 5650 in epsg.plb is different from the official definition of EPSG:5650 in the EPSG registry.

1-FN8U7B	Drag and dropping files within a ShoeBox duplicates the file instead of just moving it.	When you drag and drop a file within a Shoebox the file is duplicated instead of simply being moved. There is no need to have two entries of the same file in the ShoeBox. It used to work correctly in ERDAS IMAGINE 2014.
1-QKIBSI	ERDAS IMAGINE 2016 is unable to open standard v1.1.1 WMS	Customer reported that ERDAS IMAGINE 2016 is unable to open standard v1.1.1 WMS. Same services open successfully in other GIS applications/

IMAGINE PHOTOGRAMMETRY

CR #	Summary – IMAGINE Photogrammetry	Description / How to Reproduce
1-DSTPZJ	XPro SGM, exclusion polygon	XPro SGM online help mentions that exclusion polygon is supported but this option is not available in the SGM dialog.
1-OT8X2F	RPC generation tool doesn't generate accurate RPC00B format RPCs from WV OR2A block file.	Exporting to ISAT project is not possible if the block file is set in Rational Functions geometric model. I have tested the workaround "Using the RPC generation tool, you can generate adjusted RPC's from the block file in RPC00B format. You can then create an IKONOS ImageStation project with the exported RPC files." In order to test the accuracy of the generated RPCs I have created a block file in IKONOS RPC model and added imagery and RPC00B format RPCs. There is huge shift in IKONOS RPC block that I created after RPC generation. In my triangulated WV RPC block GCPs were right on spot. The data is on: \\alpha\Siebel_Bug_Data\1-OT8X2F
1-LC9W5H	Point Cloud Classify tool is not writing the projection of the input las data to the output file.	Classify tool in Point Cloud is not writing projection information in the output file if the projection is stored in aux file, not from the input las file.
1-M0O60Y	Point Cloud to Raster operator is not creating correct RGB raster	Point Cloud to Raster operator is not creating RGB raster output from Point cloud RGB encoded input data. The output image shows Intensity, Green and Blue.
1-LWVDOP	Error messages when displaying LAS 1.4 data in 2D viewer	Some Point cloud data in LAS 1.4 format are not displayed properly in IMAGINE 2D viewer. You will get several error messages when trying to load the data.

IMAGINE PROFESSIONAL

CR #	Summary – IMAGINE Professional	Description / How to Reproduce
1-KYQVLT	Signature Editor crashes when merging signatures with negative values	Signature Editor crashes when merging signatures that contain negative values in their statistics.



1-B9XSYL	Incorrect error creating sub-model.	In the Spatial Model Editor selecting seemingly continuous groups of Operators and trying to create a sub-model from the selection can result in an error message: "Cannot create subprocess from this selection. Must select a continuous piece of the model."
1-BC4AGD	Renamed Commandline operator set back to default commandline name after editing anything in the operator	Customer reported that a renamed Commandline operator is set back to its default commandline name after editing anything in the operator. This is a problem for user having multiple CommandLine operators in the same model. When they edit anything in the renamed commandline operator, the operator immediately changes it's name to the default name, even though you had renamed it before starting to edit. Then Spatial Modeler complains that there are several with same commandline name.
1-KZ8EKT	Summary operator causes instability (and crash) of ERDAS IMAGINE	Using a specific Zonal Summary model which basically takes a shapefile as raster as the Zones, a floating point image as the Class Raster and feeds them into Summary. Run the model once and it completes. Change the multiplier (from 10000 to 1), or some other parameter of the model, and run again and ERDAS IMAGINE crashes. Sometimes it even crashes the first time you run.
1-L51HZL	Typing @ and hitting Enter in Operator properties crashes ERDAS IMAGINE	Start a Spatial Model Editor. Drag the Eq operator onto the canvas. Select the Operator. In Properties, place cursor in the Value field of Input2 and type @ and then hit Enter. ERDAS IMAGINE crashes. This was encountered because of trying to type "2D", but had the Shift key held down when typing the 2.
1-LSDYMN	Large (multi-GB) ECW files will no longer Preview in NDVI	<p>Display large (multi-GB) ColorIR ECW in 2D View.</p> <p>On the Raster tab select NDVI.</p> <p>On the NDVI GUI click Preview.</p> <p>Note that the results never display.</p>
1-LWW5C9	Create RSETs crashes ERDAS IMAGINE if image has previously been opened	<p>Display (specific) TIFF in a 2D View.</p> <p>Clear the View.</p> <p>Start Spatial Model Editor.</p> <p>Add a Create RSETs operator.</p> <p>Define the TIFF as the input file.</p> <p>Click Run.</p> <p>ERDAS IMAGINE crashes.</p>
1-M0H0QW	OLH for Attach Vertical CRS is out of date	The OLH for Attach Vertical CRS does not match the released version of the operator. It has the wrong port names and refers to rasters only.
1-M0HN27	Spatial Model ran in Beta, but fails to run in Release	A specific model no longer runs in ERDAS IMAGINE 2016, but did apparently run in the Beta build 5306. When Run, it runs for about 50 minutes and then crashes ERDAS IMAGINE
1-M0O5O2	"Point Cloud to Raster" operator is creating partial	Point Cloud to Raster operator generates partial output raster image. For instance, the output raster may be created only for the left half of the point cloud data extent.

	output raster image	
1-M19F6D	Define Processing Area changing pixel size of ortho image	Running an ortho raster through Define Processing Area, with all of the options (including Cell Size) set to "same as input 1", creates a raster with a slightly different pixel size. The specific model tested has two paths RasterIn->RasterOut and RasterIn->DefineProcessingArea->RasterOut. The grid, cell size, window and CRS options of the DPA operator are all set to the single, input raster. The input image is an ortho in Geographic (Lat/Lon) with a cell size with many, many decimal places. The output of the RasterIn->RasterOutput path is a raster with <u>exactly</u> the same Map Info as the input. The output of the RasterIn->DefineProcessingArea->RasterOut path is a raster with <u>almost</u> the same Map Info as the input, but the pixel size is <u>slightly</u> different (4.9526297953630142e-006 vs 4.9526297953630142e-006).

IMAGINE ADVANTAGE

CR #	Summary –IMAGINE Advantage	Description / How to Reproduce
1-LX0KBG	CSM Plugin Manager will not register CSM.dll	CSM.dll cannot be added in the CSM plugin. The CSM is for a specific sensor. To replicate: File > Configuration > CSM Plugin Manager - Use CSM Plugin library selector to select CSM.dll. At this point the Runtime Library menu is updated to Visual Studio 2008 but no model is added to the Available Models section.
1-LW6IFI	MosaicPro produces line gap between abutting edges of tiles with the same projection	A single line gap is seen when mosaicking tiles that have abutting edges and are registered to an identical projection. The viewer mosaics the tile together as expected.

IMAGINE AUTO DTM

CR #	Summary – IMAGINE Auto DTM	Description / How to Reproduce
1-LR240I	Tridicon SGM crashes when generating pyramid layers	For aerial frame projects, if images do not have pyramids in the format needed by Tridicon SGM, the process generates those pyramid layers. In ERDAS IMAGINE 2016, SGM crashes during the pyramid generation process.

IMAGINE STEREO ANALYST

CR #	Summary – IMAGINE Stereo Analyst	Description / How to Reproduce
1-KZ8UR1	Y Parallax at the oriented A3 imagery in Stereo Analyst	There is a large y-parallax in Stereo Analyst for IMAGINE that is not seen in Terrain Editor. Zooming in to a better ratio than 1:1 or setting epipolar update mode to motion doesn't remove the y-parallax.
1-MEG1CN	Opening Space Imaging IKONOS Stereo Pair in Stereo Analyst for IMAGINE	Steps to reproduce:



crashes

1. Launch ERDAS IMAGINE, Stereo Analyst from Toolbox tab > Stereo Analyst.
2. Launch File > Open > Space Imaging IKONOS Stereo Pair
3. Select the file *_metadata.txt file
4. Stereo Analyst for IMAGINE hangs and crashes

PRO600

CR #	Summary – PRO600	Description / How to Reproduce
1-JSPK9S	Cursor hangs in MicroStation window.	When working with ADS data, the cursor in MicroStation window does not follow the cursor in the viewplex window. As you roam in the viewplex window, the cursor in the MSTN window hangs and catches up when the cursor in the viewplex window stops moving.

ABOUT US

Hexagon Geospatial helps you make sense of the dynamically changing world. We enable you to envision, experience and communicate geographic information. Our technology provides you the form to design, develop and deliver solutions that solve complex, real-world challenges. Ultimately, this is realized through our creative software products and platforms.

CUSTOMERS. Globally, a wide variety of organizations rely on our products daily including local, state and national mapping agencies, transportation departments, defense organizations, engineering and utility companies, and businesses serving agriculture and natural resource needs. Our portfolio enables these organizations to holistically understand change and make clear, reliable decisions.

TECHNOLOGY. Our priority is to deliver products, platforms and solutions that make our customers successful. Hexagon Geospatial is focused on developing technology that displays and interprets information in a personalized, meaningful way. We enable you to transform location-based content into dynamic and useable business information that creatively conveys the answers you need.

PARTNERS. As an organization, we are partner-focused, working alongside our channel to ensure we succeed together. We provide the right platforms, products, and support to our business partners so that they may successfully deliver sophisticated solutions for their customers. We recognize that we greatly extend our reach and influence by cultivating channel partner relationships both inside and outside of Hexagon.

TEAM. As an employer, we recognize that the success of our business is the result of our highly motivated and collaborative staff. At Hexagon Geospatial, we celebrate a diverse set of people and talents, and we respect people for who they are and the wealth of knowledge they bring to the table. We retain talent by fostering individual development and ensuring frequent opportunities to learn and grow.

HEXAGON. Hexagon's solutions integrate sensors, software, domain knowledge and customer workflows into intelligent information ecosystems that deliver actionable information. They are used in a broad range of vital industries.

Hexagon (Nasdaq Stockholm: HEXA B) has more than 16,000 employees in 46 countries and net sales of approximately 3.4bn USD. Learn more at hexagon.com and follow us @HexagonAB.



Copyright

© 2016 Intergraph® Corporation and/or its affiliates. Hexagon Geospatial is a Division of Intergraph. All Rights Reserved.

Product Documentation Terms of Use

PLEASE READ THESE TERMS CAREFULLY BEFORE USING HEXAGON GEOSPATIAL'S DOCUMENTATION ("DOCUMENT"). USE OF THIS DOCUMENT INDICATES ACCEPTANCE OF THIS AGREEMENT WITHOUT MODIFICATION. IF YOU DO NOT AGREE TO THE TERMS HEREOF ("TERMS"), DO NOT USE THIS DOCUMENT.

Use Of This Document

All materials in this Document are copyrighted and any unauthorized use may violate worldwide copyright, trademark, and other laws. Subject to the terms of this Agreement, Hexagon Geospatial (a Division of Intergraph Corporation) and Intergraph's subsidiaries ("Intergraph") hereby authorize you to reproduce this Document solely for your personal, non-commercial use. In consideration of this authorization, you agree to retain all copyright and other proprietary notices contained therein. You may not modify the Materials in any way or reproduce or publicly display, perform, or distribute or otherwise use them for any public or commercial purpose, except as specifically authorized in a separate agreement with Hexagon Geospatial.

The foregoing authorization specifically excludes content or material bearing a copyright notice or attribution of rights of a third party. Except as expressly provided above, nothing contained herein shall be construed as conferring by implication, estoppel or otherwise any license or right under any copyright, patent or trademark of Hexagon Geospatial or Intergraph or any third party.

If you breach any of these Terms, your authorization to use this Document automatically terminates. Upon termination, you will immediately destroy any downloaded or printed Materials in your possession or control.

Disclaimers

ALL MATERIALS SUPPLIED HEREUNDER ARE PROVIDED "AS IS", WITHOUT WARRANTY OF ANY KIND, EITHER EXPRESSED OR IMPLIED, INCLUDING, BUT NOT LIMITED TO, ANY IMPLIED WARRANTIES OF MERCHANTABILITY, FITNESS FOR A PARTICULAR PURPOSE, OR NON-INFRINGEMENT. Hexagon Geospatial does not warrant that the content of this Document will be error-free, that defects will be corrected, or that any Hexagon Geospatial Website or the services that make Materials available are free of viruses or other harmful components.

Hexagon Geospatial does not warrant the accuracy and completeness of this Document. Hexagon Geospatial may make changes to this Document at any time without notice.

Limitation Of Liability

IN NO EVENT SHALL HEXAGON GEOSPATIAL BE LIABLE FOR ANY DIRECT, INDIRECT, INCIDENTAL, SPECIAL OR CONSEQUENTIAL DAMAGES, OR DAMAGES FOR LOSS OF PROFITS, REVENUE, DATA OR USE, INCURRED BY YOU OR ANY THIRD PARTY, WHETHER IN AN ACTION IN CONTRACT OR TORT, ARISING FROM YOUR ACCESS TO, OR USE OF, THIS DOCUMENT.

Indemnification

You agree to defend, indemnify, and hold harmless Hexagon Geospatial, its officers, directors, employees, and agents from and against any and all claims, liabilities, damages, losses or expense, including reasonable attorneys fees and costs, arising out of or in any way connected with your access to or use of this Document.

Use Of Software

Use of software described in this Document is subject to the terms of the end user license agreement that accompanies the software, if any. You may not download or install any software that is accompanied by or includes an end user license agreement unless you have read and accepted the terms of such license agreement. Any such software is the copyrighted work of Hexagon Geospatial, Intergraph or its licensors.

Links To Third Party Websites

This Document may provide links to third party websites for your convenience and information. Third party websites will be governed by their own terms and conditions. Hexagon Geospatial does not endorse companies or products to which it links.

Third party websites are owned and operated by independent parties over which Hexagon Geospatial has no control. Hexagon Geospatial shall not have any liability resulting from your use of the third party website. Any link you make to or from the third party website will be at your own risk and any information you share with the third party website will be subject to the terms of the third party website, including those relating to confidentiality, data privacy, and security.

Trademarks

The trademarks, logos and service marks ("Marks") displayed in this Document are the property of Hexagon Geospatial, Intergraph or other third parties. Users are not permitted to use Marks without the prior written consent of Hexagon Geospatial, Intergraph or the third party that owns the Mark. "Intergraph" is a registered trademark of Intergraph Corporation in the United States and in other countries. Other brands and product names are trademarks of their respective owners.

Find additional trademark information.

Procedure For Making Claims Of Copyright Infringement

Notifications of claimed copyright infringement should be sent to Hexagon Geospatial by mail at the following address: Intergraph Corporation, Attn: Intergraph Legal Department, P.O. Box 240000, Huntsville, Alabama 35824.

US Government Restricted Right

Materials are provided with "RESTRICTED RIGHTS." Use, duplication, or disclosure of Materials by the U.S. Government is subject to restrictions as set forth in FAR 52.227-14 and DFARS 252.227-7013 et seq. or successor provisions thereto. Use of Materials by the Government constitutes acknowledgement of Hexagon Geospatial or Intergraph's proprietary rights therein.

International Use

You may not use or export Materials in violation of U.S. export laws and regulations. Hexagon Geospatial makes no representation that Materials are appropriate or available for use in every country, and access to them from territories where their content is illegal is prohibited.

Hexagon Geospatial provides access to Hexagon Geospatial international data and, therefore, may contain references or cross references to Hexagon Geospatial products, programs and services that are not announced in your country. These references do not imply that Hexagon Geospatial intends to announce such products, programs or services in your country.

The Materials are subject to U.S. export control and economic sanctions laws and regulations and you agree to comply strictly with all such laws and regulations. In addition, you represent and warrant that you are not a national of, or otherwise located within, a country subject to U.S. economic sanctions (including without limitation Iran, Syria, Sudan, Cuba, and North Korea) and that you are not otherwise prohibited from receiving or accessing the Materials under U.S. export control and economic sanctions laws and regulations. Hexagon Geospatial makes no representation that the Materials are appropriate or available for use in every country, and access to them from territories where their content is illegal is prohibited. All rights to use the Materials are granted on condition that such rights are forfeited if you fail to comply with the terms of this agreement.

Revisions

Hexagon Geospatial reserves the right to revise these Terms at any time. You are responsible for regularly reviewing these Terms. Your continued use of this Document after the effective date of such changes constitutes your acceptance of and agreement to such changes.

Applicable Law

This Document is created and controlled by Hexagon Geospatial in the State of Alabama. As such, the laws of the State of Alabama will govern these Terms, without giving effect to any principles of conflicts of law. You hereby irrevocably and unconditionally consent to submit to the exclusive jurisdiction of the United States District Court for the Northern District of Alabama, Northeastern Division, or the Circuit Court for Madison County, Alabama for any litigation arising out of or relating to use of this Document (and agree not to commence any litigation relating thereto except in such courts), waive any objection to the laying of venue of any such litigation in such Courts and agree not to plead or claim in any such Courts that such litigation brought therein has been brought in an inconvenient forum. Some jurisdictions do not allow the exclusions or limitations set forth in these Terms. Such exclusions or limitations shall apply in all jurisdictions to the maximum extent allowed by applicable law.

Questions

Contact us with any questions regarding these [Terms](#).

